

OUTLINE DIMENSIONAL DRAWING

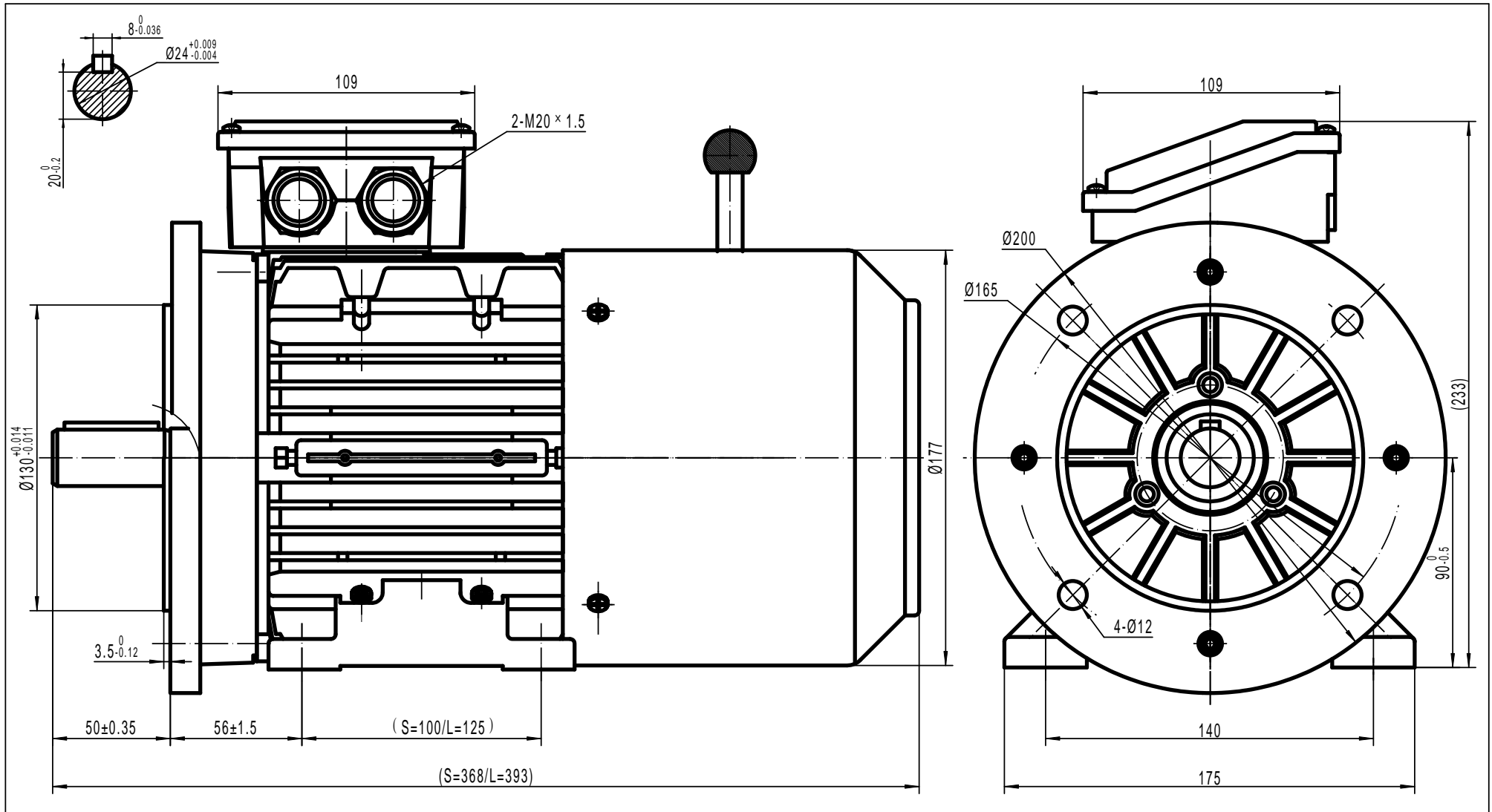

TECHTOP AUSTRALIA PTY LTD	
FRAME	TAIB 90A B35
DATE	DRAWING NO.
2013/10/22	1ST103.051.001-021 A